



# **1998-99 DODGE CUMMINS 24V ISB**

## ***OEM BYPASS LIFT PUMP KIT***

### **Installation Instructions**

**Part# 1050230**

**PLEASE READ ALL INSTRUCTIONS CAREFULLY BEFORE INSTALLATION.**











BD Engine Brake Inc.

Plant Address: Unit A10, 33733 King Rd, Abbotsford, BC, Canada V2S 7M9

U.S. Shipping Address: 88-446 Harrison St, Sumas, WA 98295 U.S. Mailing Address: P.O. Box 231, Sumas, WA 98295

Phone: 604-853-6096 Fax: 604-853-8749 Internet: [www.bd-power.com](http://www.bd-power.com)

## Kit Contents

|   |   |   |   |
|---|---|---|---|
| <p><b>P4601HP</b></p>    | <p><b>1100111</b></p>    | <p><b>1230116</b></p>   | <p><b>1300131</b></p>  |
| <p><b>Auxiliary Lift Pump Assy. ***</b><br/>Qty: 1</p>  | <p><b>Flat Washer</b><br/>Qty: 6</p>  | <p><b>Lock Nut</b><br/>Qty: 6</p>   | <p><b>Tie Wrap (Medium)</b><br/>Qty: 5</p>  |
| <p><b>1300220</b></p>    | <p><b>1330149</b></p>    | <p><b>1400120</b></p>  |   |
| <p><b>Anti-Vibration Mount</b><br/>Qty: 3</p>   | <p><b>Hose Clamp</b><br/>Qty: 4</p>   | <p><b>3/8\"NPT x 3/8\"PO Fitting</b><br/>Qty: 2</p>   |   |
| <p><b>1502027</b></p>  | <p><b>1500231</b></p>  | <p><b>1502021</b></p>                                      |   |
| <p><b>Lift Pump Wiring Harness</b><br/>Qty: 1</p>   | <p><b>Banjo Fitting; Metric Union</b><br/>Qty: 1</p>  | <p><b>Pressure Switch</b><br/>Qty: 1 x 25" / 1 x 60"</p>  |   |
| <p><b>1502019</b></p>   |   |   |                        |
| <p><b>O-Ring Seal Washer</b><br/>Qty: 2</p>   |   |   |   |

**\*\*\* Fuel Pump parts bag contains additional parts – only use the following:  
2 – hose clamps, 3 – rubber isolators, 3 – flat washers, lock washers & nuts**

## Optional Accessories

- 1081130 - Low Fuel Pressure LED Alarm kit
- 1085210 – X-Monitor Digital Gauge Package
- 1080156 – Fuel Pressure Kit (X-Monitor Accessory)

## Installation

1. Disconnect both batteries.
2. Raise the vehicle and support it safely.
3. Locate and remove the factory lift pump and all connecting lines. You will need to disconnect the fuel line connecting to the lift pump as well as the fuel line that travels from the lift pump to the fuel filter. Note that you will not be able to fully remove the fuel supply line to the pump yet as you will need to cut the existing fuel line. This step is outlined in the next section.

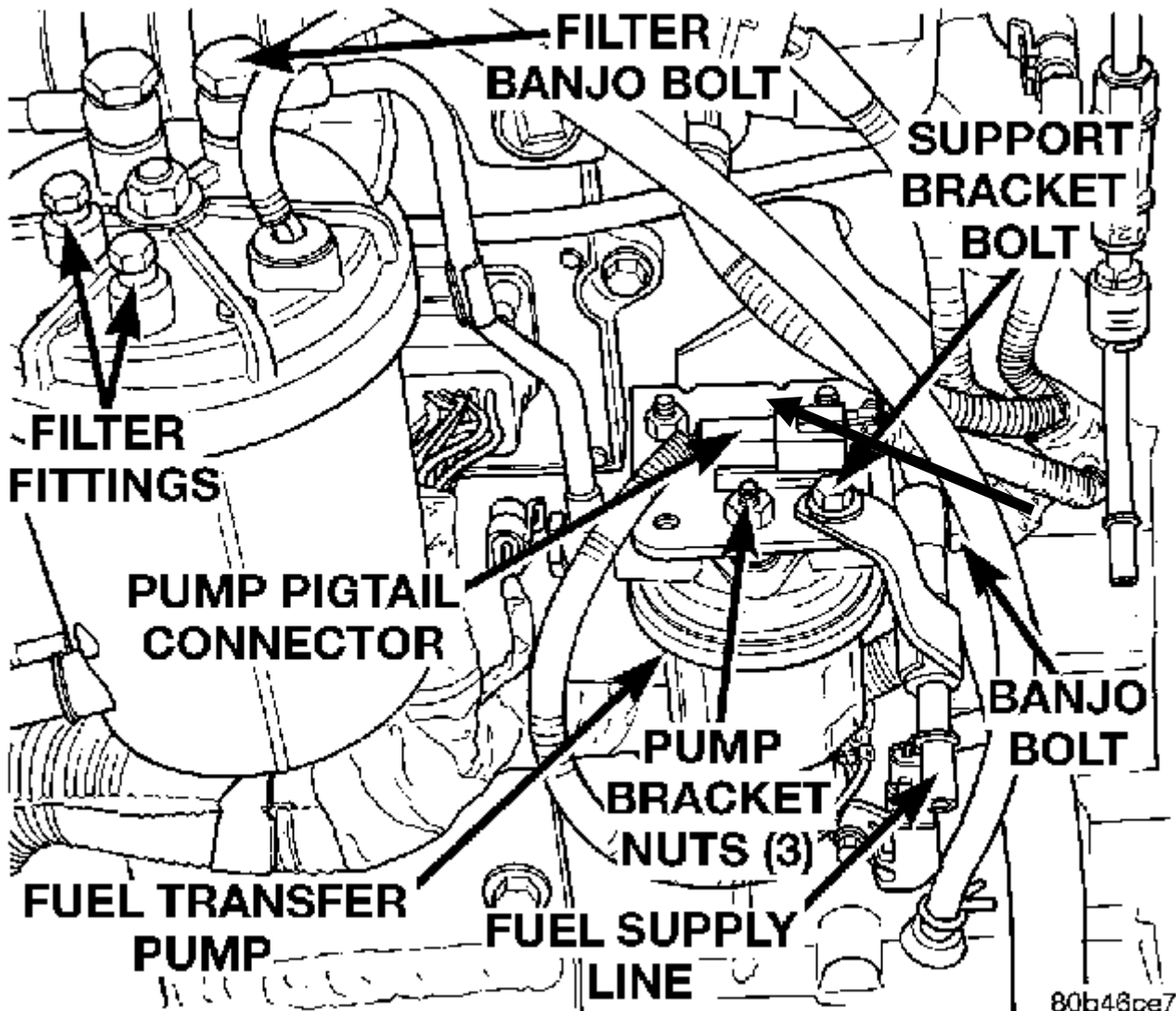

***Remove lift pump and all connecting fuel lines.***

BD Engine Brake Inc.

Plant Address: Unit A10, 33733 King Rd, Abbotsford, BC, Canada V2S 7M9

U.S. Shipping Address: 88-446 Harrison St, Sumas, WA 98295 U.S. Mailing Address: P.O. Box 231, Sumas, WA 98295

Phone: 604-853-6096 Fax: 604-853-8749 Internet: [www.bd-power.com](http://www.bd-power.com)

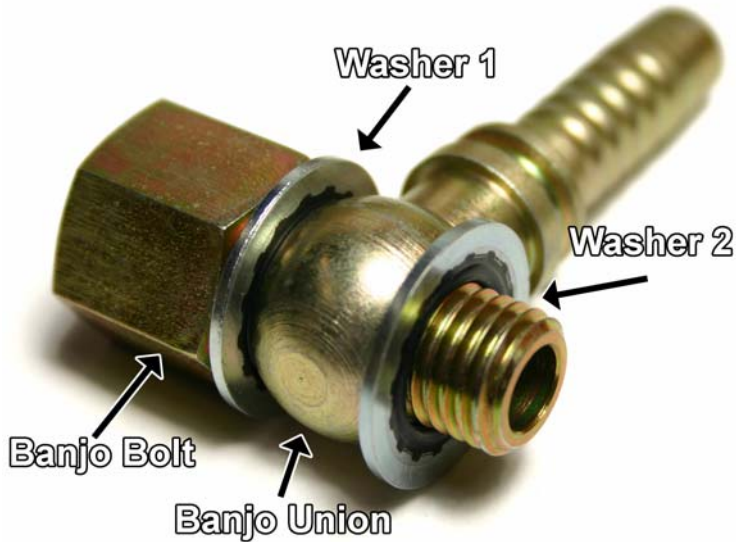

4. Connect the factory banjo bolt (removed from the pump) & the banjo union (supplied) with the new washers on the rear port of the filter housing. Don't forget to install the vulcanized rubber washers on both sides of the banjo bolt.

5. Connect the fuel line extension hose to the adapter fitting. Make sure that by re-routing the hose it doesn't rub on anything. This

hose should be routed along the same path as the factory fuel line once did. Once the pump installation is completed, this fuel line hose will be connected to the "OUT" port of the replacement pump.

## Pump Installation

6. Locate a spot on the driver's side frame rail near the frame opening so you can get the nuts and lock washers onto the back of the rubber isolators. Alternately if you cannot get to the backside frame to install the lock washers and nuts, you can drill and tap the holes to ¼ NC (drill bit #7 or 13/64") for mounting the rubber isolators. If you choose this method be sure to use Loc-tite on the threads.

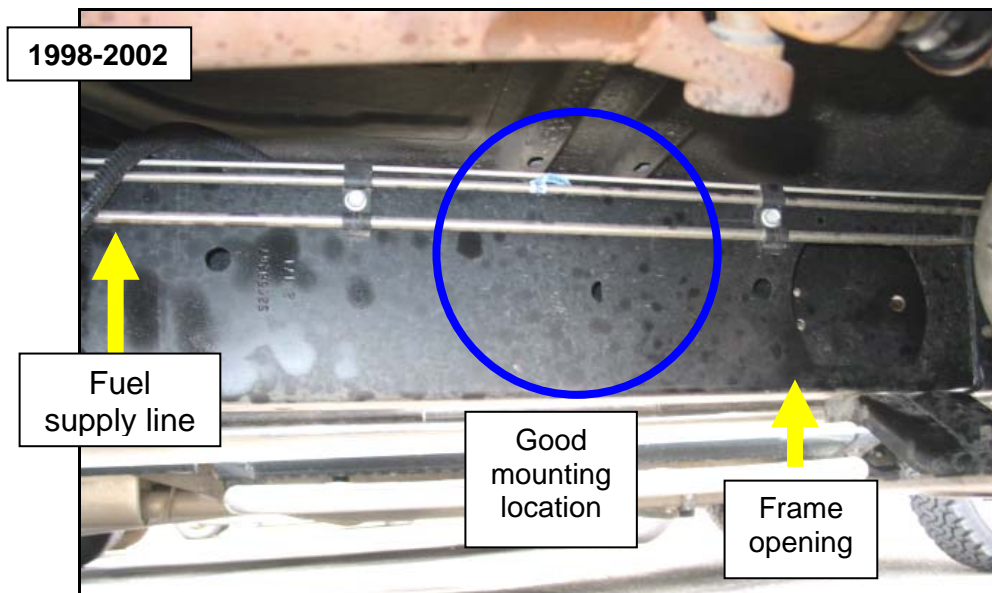

7. Cut the steel fuel supply line and remove a 14" section, centered on the location you chose to mount the mounting at. A pipe cutter is strongly recommended to cut the line, be sure not to squish or compress the fuel line, and remove any

BD Engine Brake Inc.

Plant Address: Unit A10, 33733 King Rd, Abbotsford, BC, Canada V2S 7M9

U.S. Shipping Address: 88-446 Harrison St, Sumas, WA 98295 U.S. Mailing Address: P.O. Box 231, Sumas, WA 98295

Phone: 604-853-6096 Fax: 604-853-8749 Internet: www.bd-power.com

burrs that are left over from the process. Note that the front section of the cut fuel line should be completely removed as it will be replaced with fuel line hose.



8. Using the pump bracket as a template, mark the three hole locations as shown and drill to 1/4". If you cannot access the rear of the frame rail you will need to drill and tap the three holes. Use drill bit #7 or 13/64, then tap to 1/4" NC.

9. Install the three rubber isolators with the long threaded end through the frame. Be sure to use Loc-tite if you are threading the isolators into the frame.
10. Install the pump bracket on to the three rubber isolators with the supplied nuts and lock washers (These parts are found inside the sealed bag inside the pump box). Mount the pump to the "L" bracket with the supplied isolators and bolts. The pump is marked inlet and outlet so be sure that the outlet is pointed of the front the front of the vehicle.
11. Install the two brass fittings in the pump - Do not use any thread sealant as this may void the warranty of the pump.
12. Install the two pieces of rubber fuel lines with one clamp on each barb fitting and two on the steel line. Tighten the hose clamps on the factory fuel line and the brass-barbed fittings.

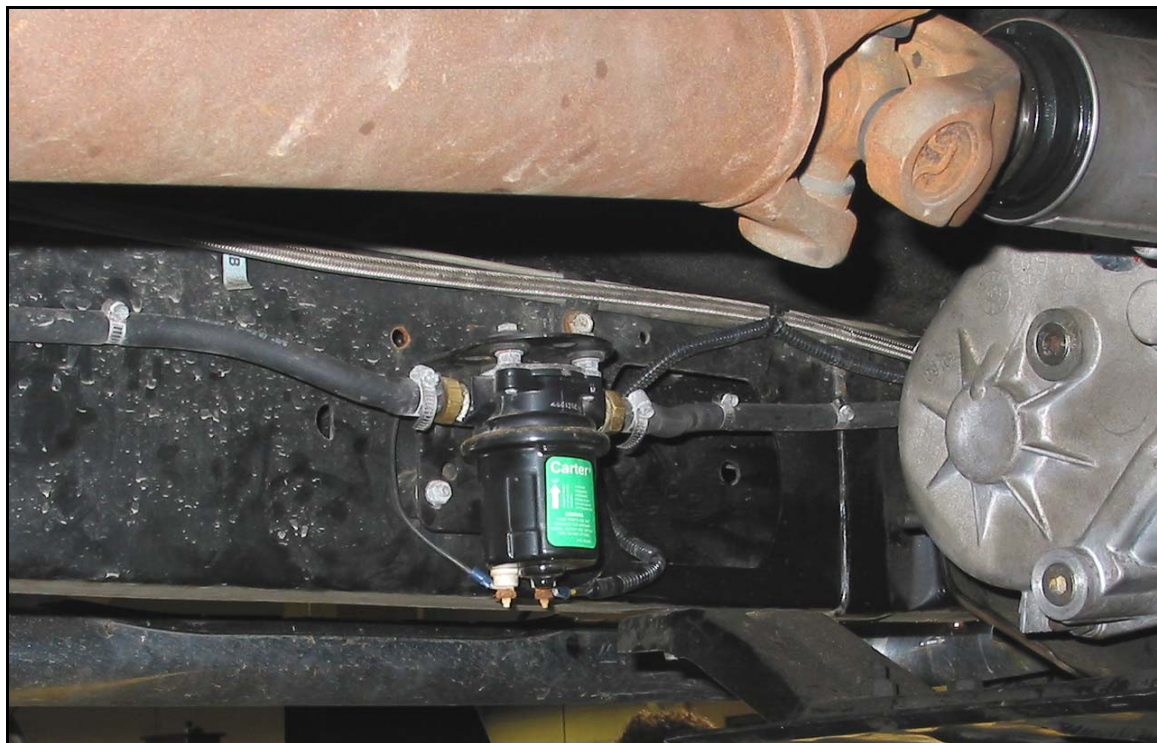

BD Engine Brake Inc.

Plant Address: Unit A10, 33733 King Rd, Abbotsford, BC, Canada V2S 7M9

U.S. Shipping Address: 88-446 Harrison St, Sumas, WA 98295 U.S. Mailing Address: P.O. Box 231, Sumas, WA 98295

Phone: 604-853-6096 Fax: 604-853-8749 Internet: [www.bd-power.com](http://www.bd-power.com)

13. Connect the wiring harness to the pump (red [+], black [-]) and run it to engine compartment along the left frame rail, securing it along the way with the provided zip ties. Then attach the harness to the factory lift pump connector on the driver's side of the engine. Coat the lift pump connections with some type of anti-seize silicone, or battery terminal paint to protect them against corrosion.
14. Reconnect the batteries and reset the radio station presets.
15. Start your engine, and verify that your pump starts when your oil pressure builds up. Check for fuel and oil leaks at the various connections made during the installation. It is also recommended that you monitor the fuel pressure initial to ensure proper operation. Typically, fuel pressure at idle should be around 12-14psi.

If you experience any problems or difficulties with this kit, please contact the BD Technical Department at 1-604-853-6096 or fax at 1-604-853-8749, between 8:00am and 4:30pm Pacific Time.



BD Engine Brake Inc.

Plant Address: Unit A10, 33733 King Rd, Abbotsford, BC, Canada V2S 7M9

U.S. Shipping Address: 88-446 Harrison St, Sumas, WA 98295 U.S. Mailing Address: P.O. Box 231, Sumas, WA 98295

Phone: 604-853-6096 Fax: 604-853-8749 Internet: [www.bd-power.com](http://www.bd-power.com)

## **BD ENGINE BRAKE**

### DISCLAIMER OF LIABILITY

Other than as expressly set forth herein, BD ENGINE BRAKE, Inc. (hereafter collectively, "SELLER"), together with its distributors, jobbers and dealers shall in no way be responsible for the PRODUCT'S proper use and service. In no event shall SELLER be liable for any special, incidental, indirect or consequential damages of any kind or nature, whether or not BUYER was advised of the possibility of damage, arising or resulting from the use or performance of the PRODUCT, and BUYER hereby waives any and all such claims.

BUYER acknowledges that he/she/it is not relying on SELLER'S skill or judgment to select or furnish goods suitable for any particular purpose and that SELLER has no liability that will extend beyond the scope of the limited warranty contained herein, and BUYER hereby waives all remedies or liabilities, expressed or implied, arising by operation of law or otherwise, (including, without limitation, any obligations of SELLER with respect to fitness for any particular purpose; merchantability; and special, incidental, indirect or consequential damages) or whether or not occasioned by SELLER'S negligence.

SELLER disclaims any warranty and expressly disclaims any liability for personal injury or damages related to BUYER'S use of the PRODUCT. BUYER acknowledges and agrees that the disclaimer of any liability for personal injury is a material term for this agreement and BUYER agrees to indemnify SELLER and hold SELLER harmless from any claim related to the PRODUCT and its use or performance. Under no circumstances will SELLER be liable for any damages, liabilities, costs or expenses incurred as a result of by reason of the use, performance or sale of the PRODUCT, including, without limitation, any damages, liabilities, costs or expenses incurred by reason of BUYER'S negligence related to those uses of the PRODUCT as a result of the removal of the speed limiter.

SELLER assumes no liability regarding the improper installation or misapplication of the PRODUCT. It is the installer's responsibility to check for proper installation, and, if in doubt, contact the manufacturer.

### LIMITATION OF WARRANTY

SELLER hereby provides the following limited warranty as to description, quality, merchantability, fitness for any product's purpose, productiveness, or any other matter of SELLER'S product sold herewith. The SELLER shall be in no way responsible for the product's open use and service and the BUYER hereby waives all rights other than those expressly written herein. This Warranty shall not be extended or varied except by a written instrument signed by SELLER and BUYER.

The Warranty is Limited to one (1) year from the date of sale and limited solely to the parts contained within the product's kit. All products that are in question of Warranty must be returned shipping prepaid to the SELLER and must be accompanied by a dated proof of purchase receipt. All Warranty claims are subject to approval by BD ENGINE BRAKE, Inc.

Under no circumstances shall the SELLER be liable for any labor charged or travel time incurred in diagnosis for defects, removal, or reinstallation of this product, or any other contingent expenses.

Under no circumstances will the SELLER be liable for any damage or expenses insured by reason of the use or sale of any such equipment.

**IN THE EVENT THAT THE BUYER DOES NOT AGREE WITH THIS AGREEMENT: THE BUYER MAY PROMPTLY RETURN THIS PRODUCT, IN A NEW AND UNUSED CONDITION, WITH A DATED PROOF OF PURCHASE, TO THE PLACE OF PURCHASE WITHIN THIRTY (30) DAYS FROM DATE OF PURCHASE FOR A FULL REFUND. THE INSTALLATION OF THIS PRODUCT INDICATES THAT THE BUYER HAS READ AND UNDERSTANDS THIS AGREEMENT AND ACCEPTS ITS TERMS AND CONDITIONS.**

BD Engine Brake Inc.

Plant Address: Unit A10, 33733 King Rd, Abbotsford, BC, Canada V2S 7M9

U.S. Shipping Address: 88-446 Harrison St, Sumas, WA 98295 U.S. Mailing Address: P.O. Box 231, Sumas, WA 98295

Phone: 604-853-6096 Fax: 604-853-8749 Internet: [www.bd-power.com](http://www.bd-power.com)